

Dławnica:

rura cylindryczna $\phi 40H8$

Tłoczysko chromowane $\phi 25f7$

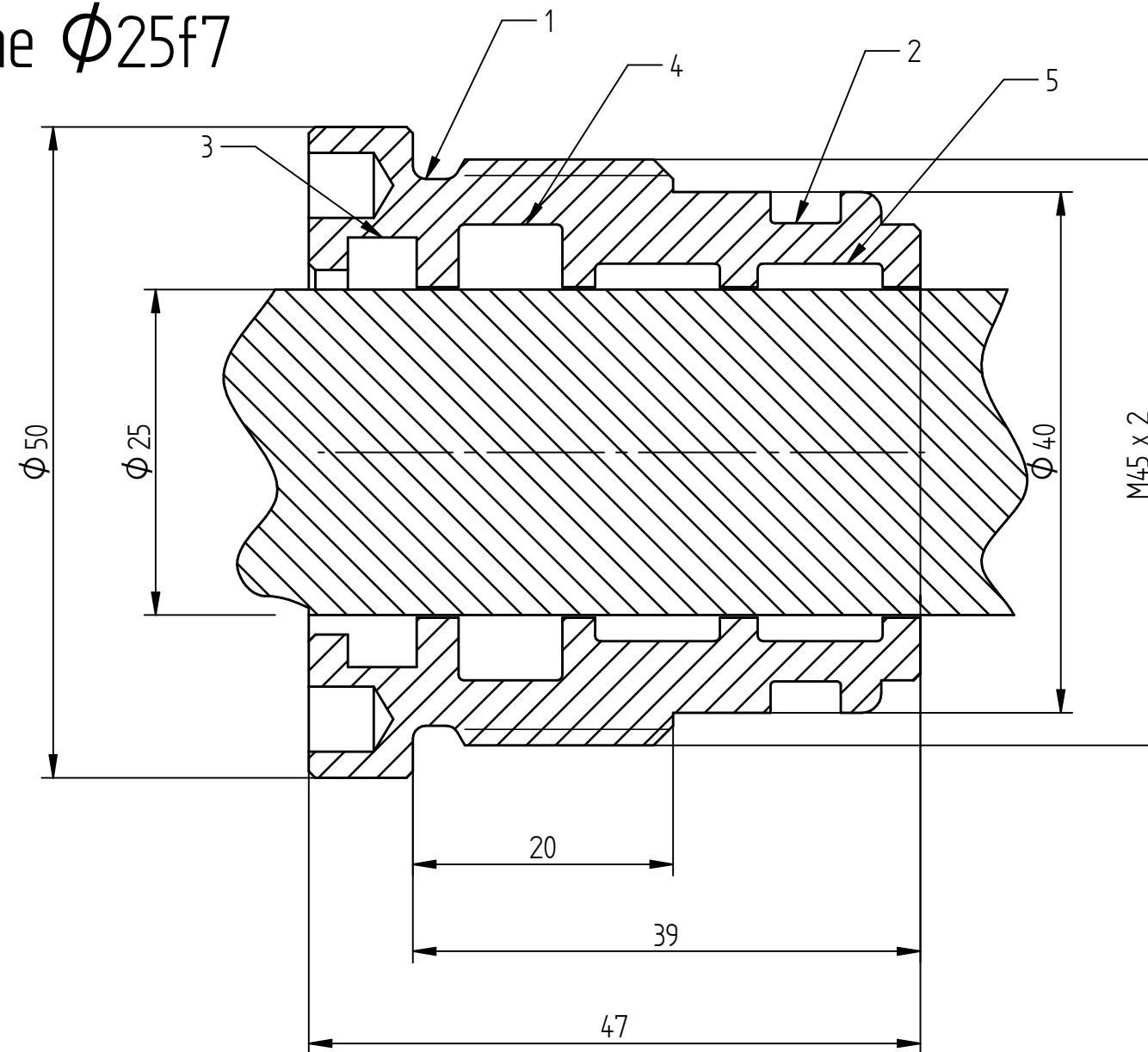

1. O-ring 40x3
2. DU0000400
3. GHK 25x33x5_7
4. TTI 25x35x7
5. AGI 25x29x9,6

HP SZCZECIN